

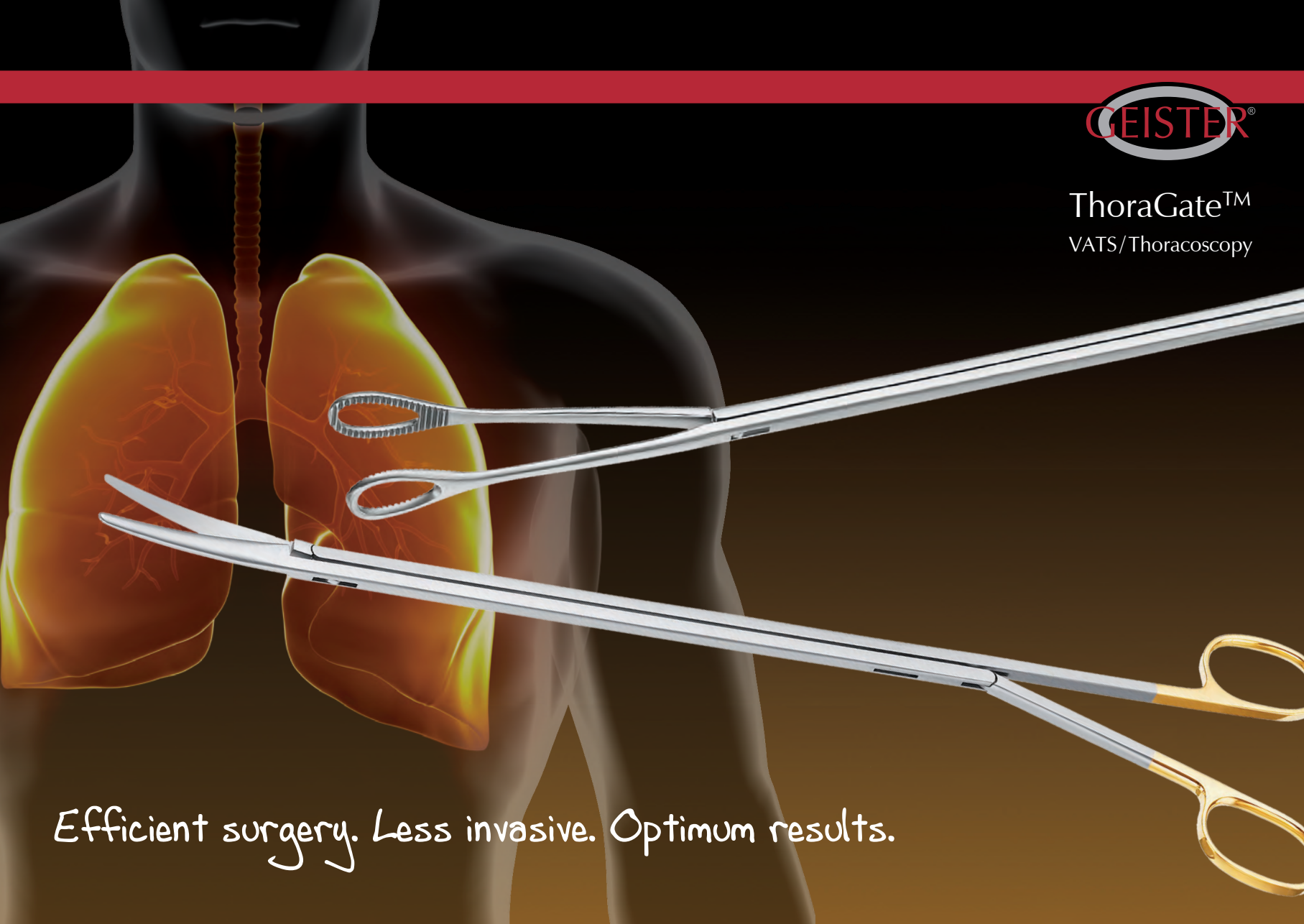

ThoraGate™
VATS/Thoracoscopy

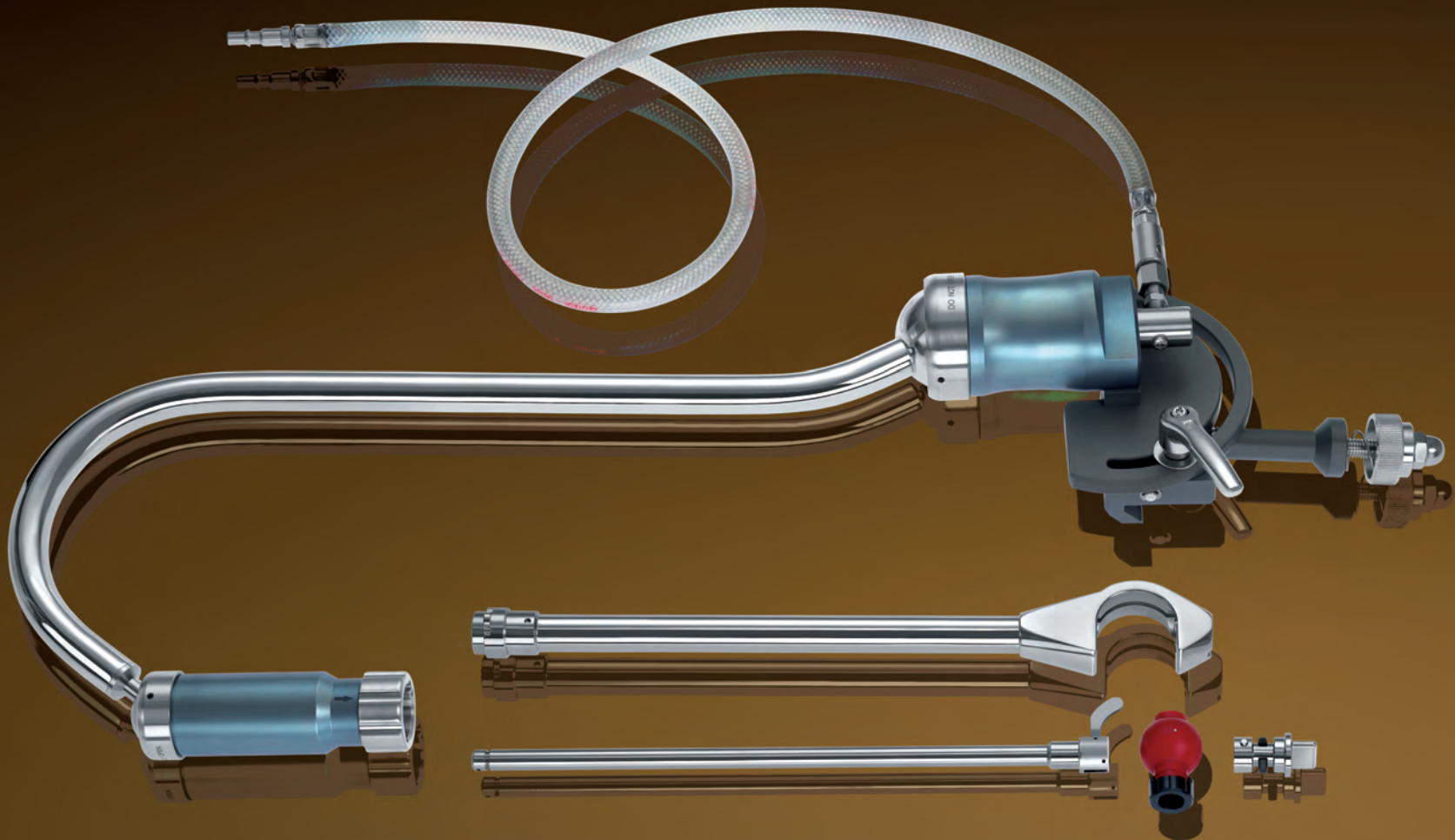

Efficient surgery. Less invasive. Optimum results.



29-5000 Iron-Assistant™ Pneumatic Endoscope Holder

for direct connection with the compressed air supply in the OR (working pressure 5 bar up to 7 bar). Enables instantaneous and unlimited one-hand manipulation of an endoscope or tube shaft instrument within the operating field followed by total steadiness and stability under load once in the „locked“ position. Easy handling and highest reliability due to the one-hand concept with only 3 hinges and the use of titanium components for weight reduction. The pneumatic arm can be easily attached to the OR table rail and is autoclavable completely or partially (if draping is preferred) for quick sterile set-up.



- 29-1481G Iron-Assistant™ Instrument Holder, extra long straight bar
 29-1481 Iron-Assistant™ Instrument Holder, L-shaped bar
 29-1481/I ditto, insulated for use with HF-surgery
 29-1482 Iron-Assistant™ Endoscope Holder, straight bar
 29-1482/I ditto, insulated for use with HF-surgery



34-7330

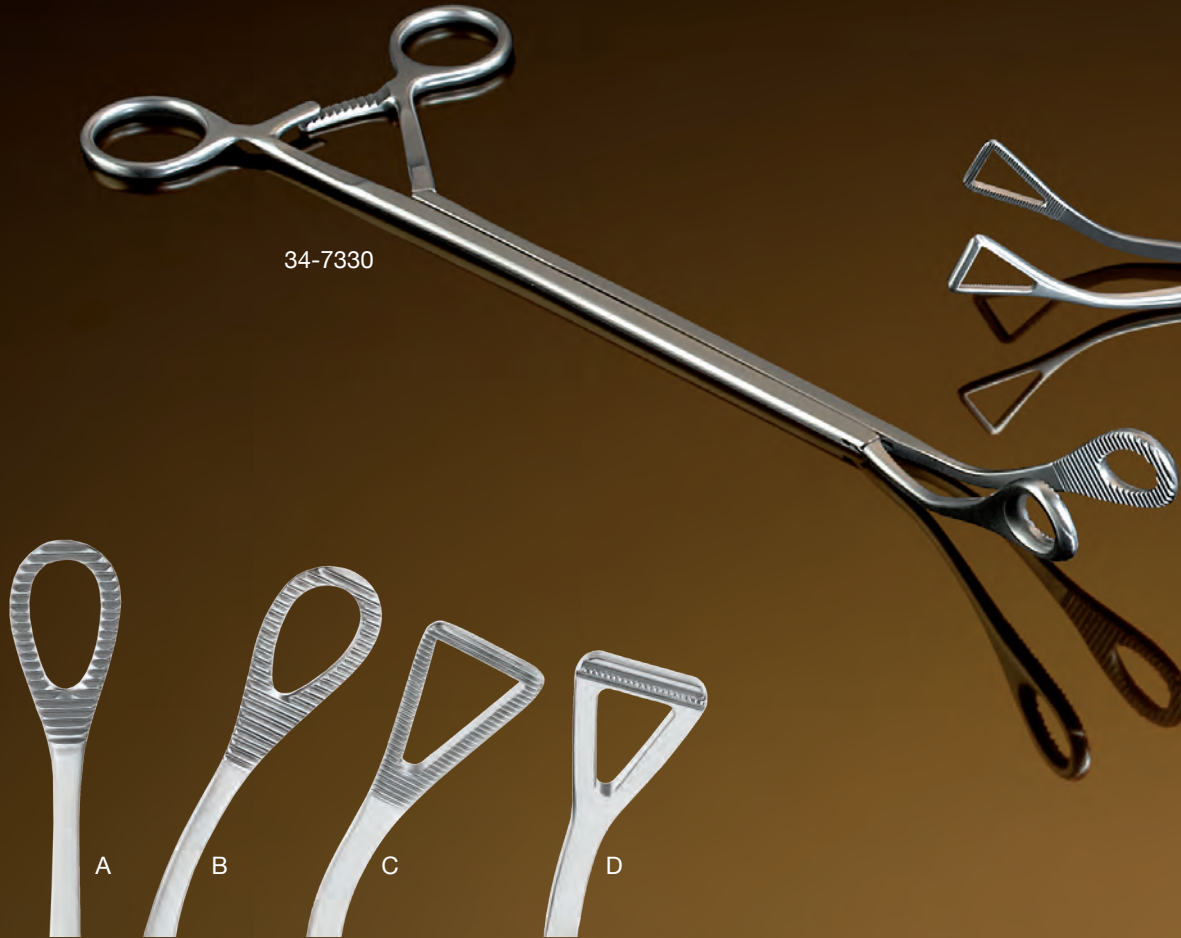



**ThoraGate™ Foerster Lung Grasper,
with ratchet, sliding shaft,
regular 10 mm**

34-7329 A 33.5 cm straight

34-7330 B 33.5 cm curved

slim 7 mm

34-7328 B 33.5 cm curved

**ThoraGate™ Atraumatic Duval Lung Grasper,
with ratchet, sliding shaft**

34-7336 C 32,5 cm

**ThoraGate™ Duval Lung Grasper,
with ratchet, sliding shaft**

34-7335 D 33,5 cm 15 mm

34-7334 D 33,5 cm 25 mm

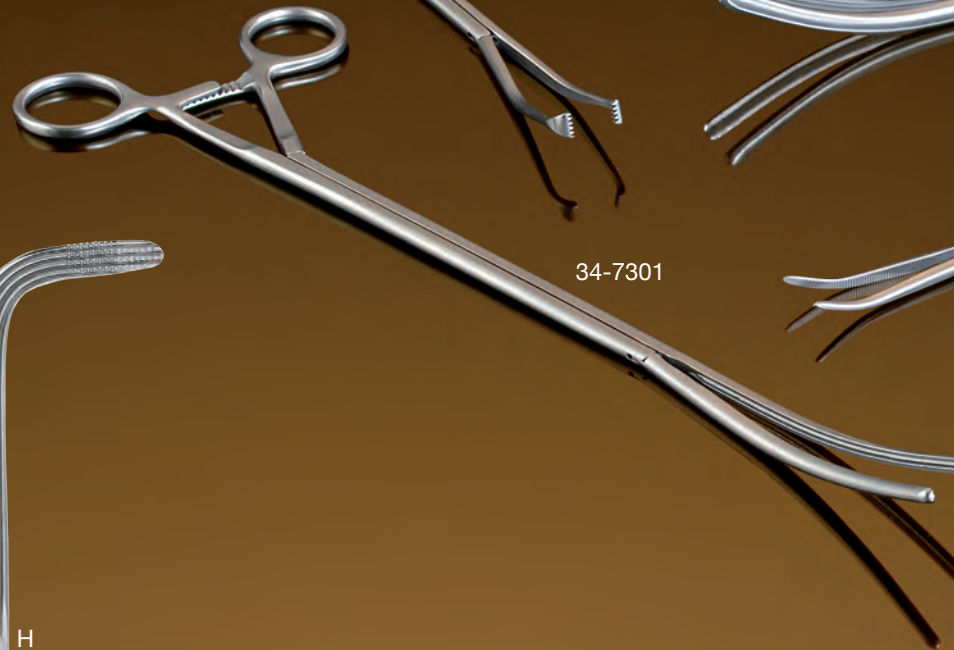

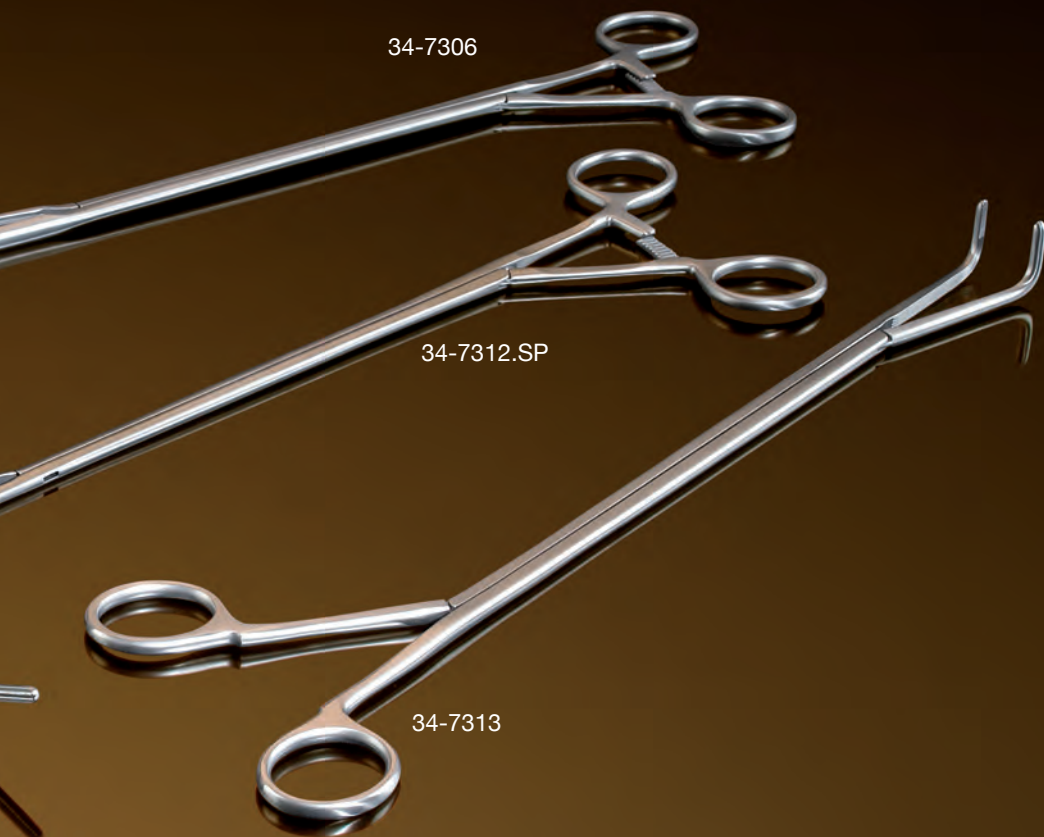

34-7306

34-7312.SP

34-7313

ValveGate™ DeBakey Transthoracic Aortic Clamp, with ratchet, regular jaw (1x2), sliding shaft

34-7301	A	36 cm	100 mm
34-7302	C	32 cm	50 mm
34-7303	B	34 cm	75 mm

ValveGate™ DeBakey Transthoracic Aortic Clamp, with ratchet, wide jaw (2x3), sliding shaft

34-7306	D	36 cm	100 mm
acutely curved			
34-7311	E	35 cm	100 mm

ThoraGate™ Dissecting Forceps, sliding shaft, without ratchet

34-7312	F	33.5 cm
with ratchet		
34-7312.SP	F	33.5 cm

ThoraGate™ Allis Grasper, sliding shaft, with ratchet

34-7325	G	34 cm
---------	---	-------

ThoraGate™ DeBakey-Cooley Forceps, sliding shaft, without ratchet

34-7313	H	35 cm
with ratchet		
34-7313.SP	H	35 cm

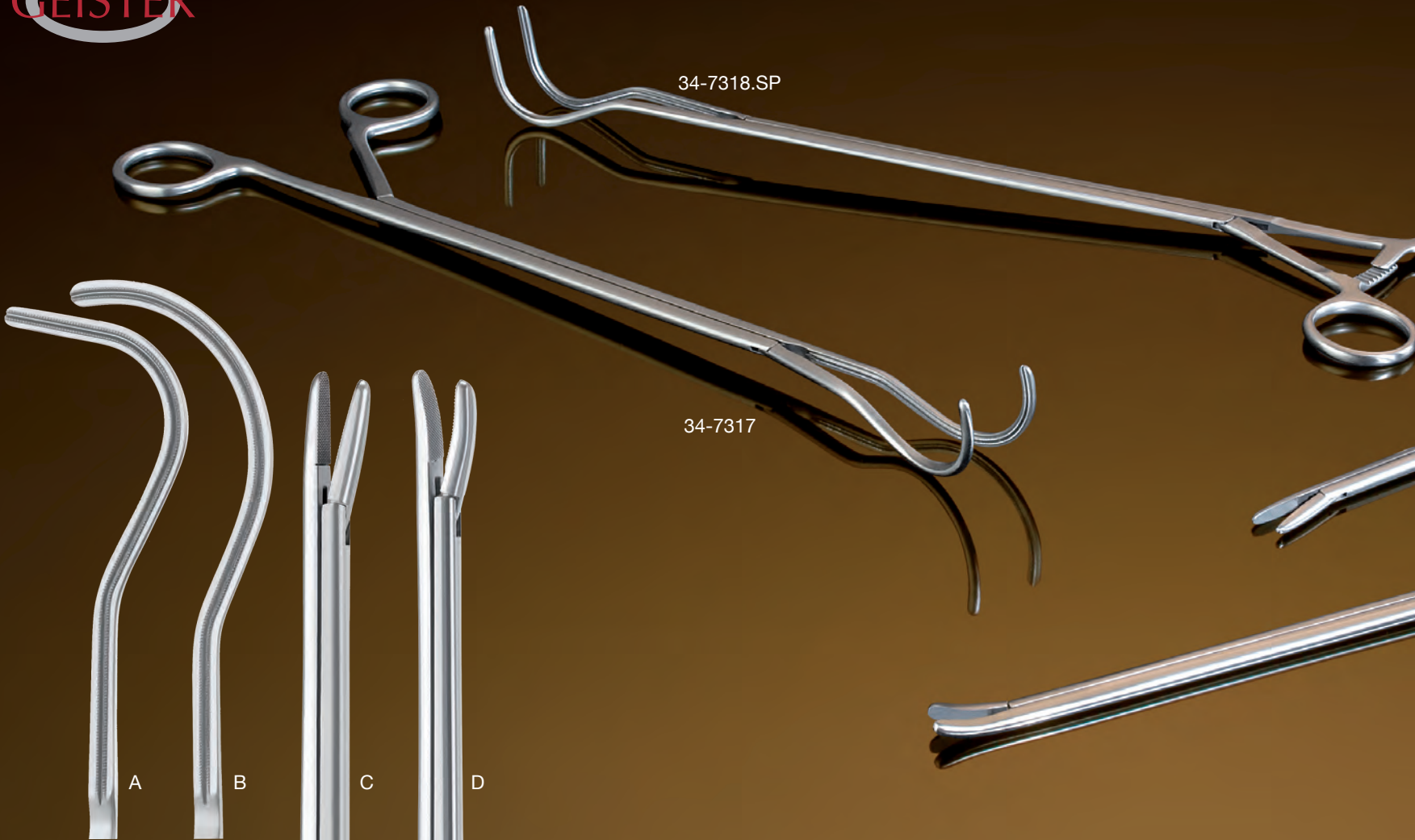

34-7318.SP

34-7317

A

B

C

D



ThoraGate™ Harken #2 Lung Clamp, sliding shaft, without ratchet

34-7318 A 35 cm

with ratchet

34-7318.SP A 35 cm

ThoraGate™ Harken #1 Lung Clamp, sliding shaft, without ratchet

34-7317 B 35 cm

with ratchet

34-7317.SP B 35 cm

ThoraGate™TC Needle Holder with ratchet, regular, sliding shaft

34-7351 C 33.5 cm 10 mm straight

(not illustrated)

34-7352 D 33.5 cm 10 mm curved

ThoraGate™TC Needle Holder with ratchet, slim, sliding shaft

34-7353 C 33.5 cm 7 mm straight

(not illustrated)

34-7354 D 33.5 cm 7 mm curved

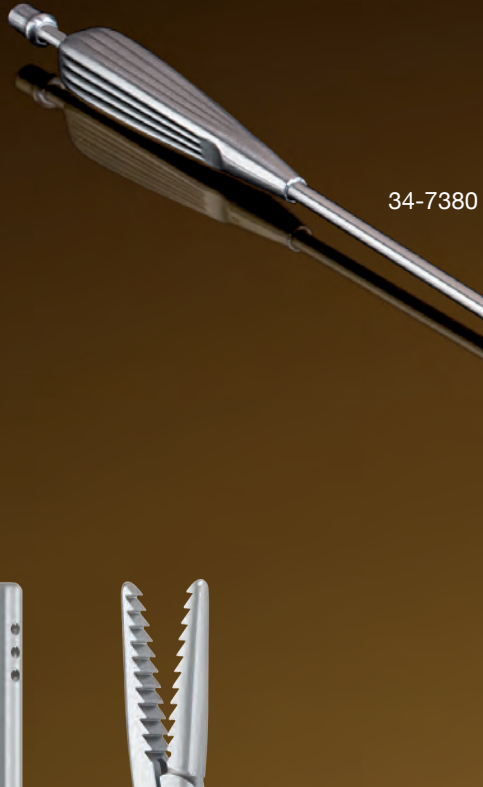

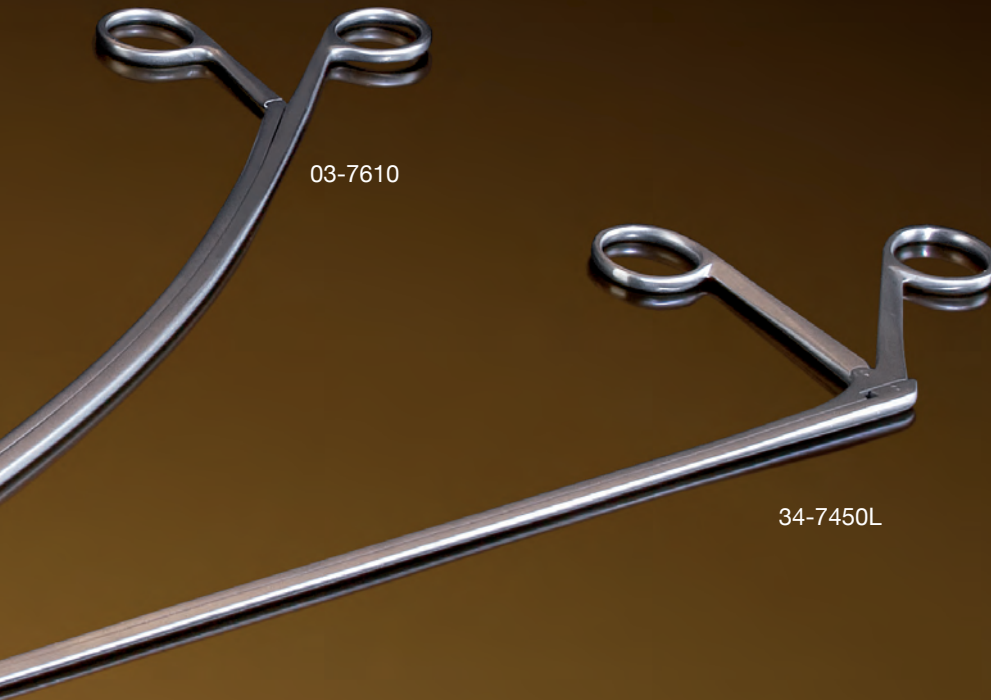

03-7610

34-7450L

**ValveGate™ Aortic Valve Rongeur/
Biopsy Forceps, 3mm, straight**

34-7450	A	30 cm
34-7450L	A	40 cm

ThoraGate™ Yankauer Suction Tube, Ø 5mm, straight

34-7380	B	46 cm
with finger hole for flow control		
34-7381	B	46 cm

**Chest Tube Passer
without ratchet**

03-7600	C	24 cm
03-7610	C	37 cm

with ratchet

03-7601	C	24 cm
03-7611	C	37 cm



26-4001

24-0540

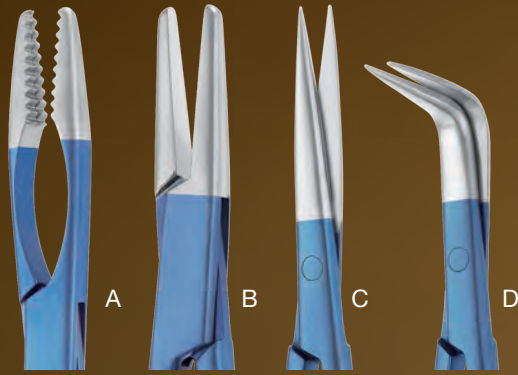

A

B

C

D



10-0255

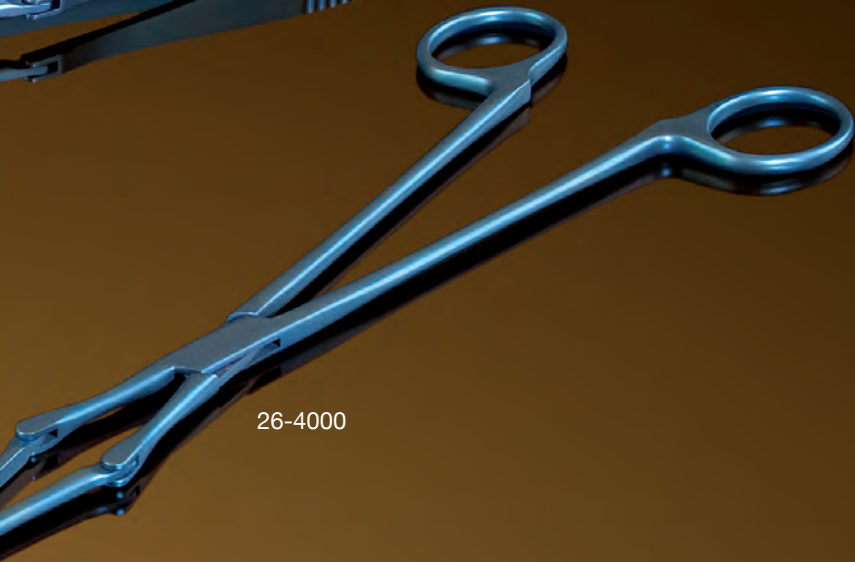

26-4000

**Resano Dissecting Forceps Titanium**

10-0255 A 28 cm

De Bakey Needle Holder Titanium

24-0540 B 28 cm

**Papillary Muscle Scissors Titanium
straight**

26-4000 C 28 cm

85° angled

26-4001 D 27 cm



A

B

C



34-7320



34-7350



34-7321

**ThoraGate™ TC Metzenbaum Scissors,
double action, medium curved**

34-7320 A 32 cm

strongly curved

34-7321 B 32 cm

**ThoraGate™ TC Needle Holder, double action,
with ratchet, straight**

34-7350 C 32 cm straight

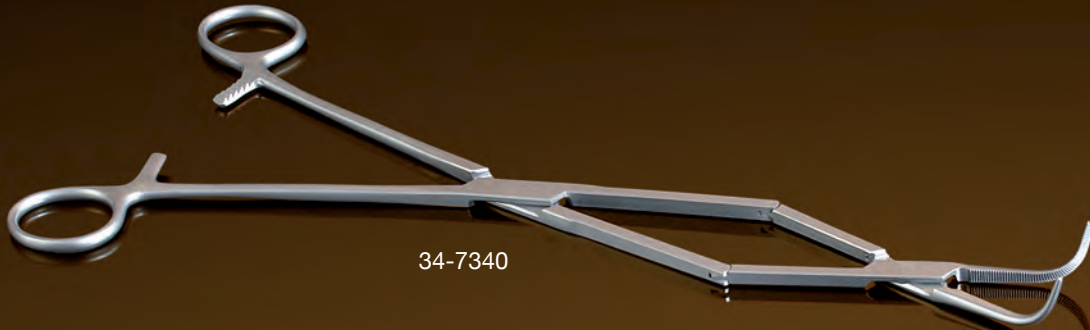

34-7340

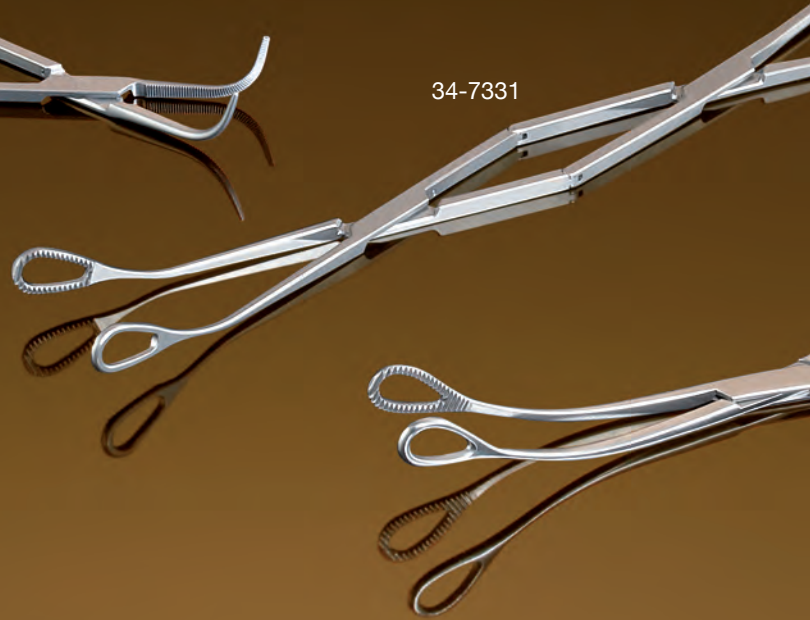

34-7331

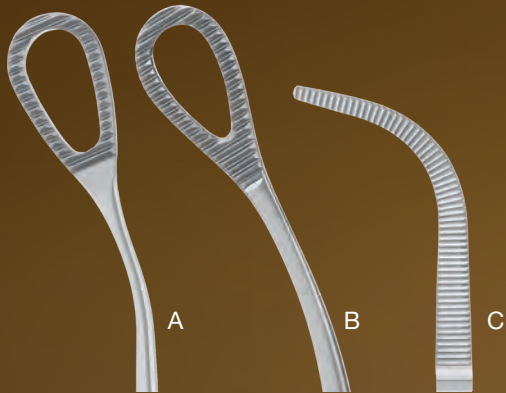

A

B

C



34-7331L

**ThoraGate™ Foerster Lung Grasper, with ratchet,
double action**

34-7331 A 35 cm

**ThoraGate™ Hallmann Lung Grasper and Femoral Art.
Tunneling Forceps with ratchet, double action**

34-7331L B 36 cm

**ThoraGate™ Mixer Dissecting Forceps
with ratchet, double action**

34-7340 C 33 cm

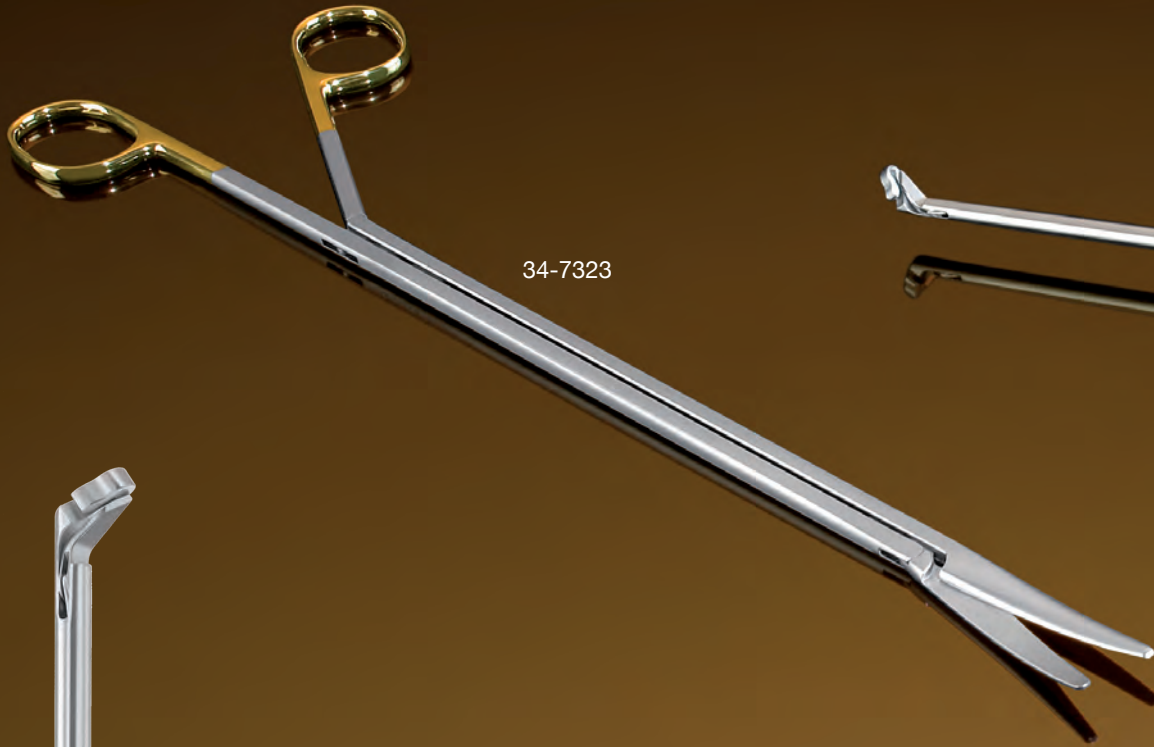

34-7323



A



B





34-8500



ThoraGate™ TC Metzenbaum Scissors
slightly curved, sliding shaft

34-7323 A 36 cm

ValveGate™ Suture Cutter

34-8500L B 43cm

34-8500 B 38cm

34-8500S B 30cm





ValveGate™ Soft Tissue Protector

The ValveGate™ Soft Tissue Protector is a sterile, single patient use wall access device consisting of 2 overlaid plastic rings that are interconnected by means of a silicone rubber membrane. The bottom ring is a flexible ring made with a shape memory alloy to be inserted in situ.

The special features are:

- clear and unimpeded access to surgical site in minimally invasive valve or bypass surgery, MIDCAB, V.A.T.S., transcatheter or transapical valve replacement a.o.
- protects wound edge and surrounding tissue
- usable with or without retractor
- can be used in combination with incision foil
- reduces risk of embolic fat particles on instruments, sutures and knot pushers
- improves visibility and exposure
- self-holding, for incisions from 6 cm to 9 cm (regular size) and from 3 cm to 5 cm (small size)
- very easy to insert in situ
- high flexibility
- latex-free silicone rubber

Art.-No. 29-1399

regular Size

Art.-No. 29-1399S

small size

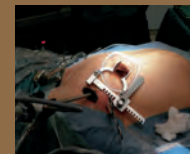
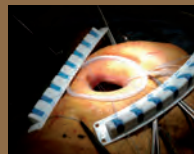

For easy placement simply push the flexible ring downwards as illustrated and insert it into the wound cavity. Then push the reversed portion carefully down as well and expand it. Remove it in the opposite way by inserting some fingers, grabbing a part of the flexible ring, and pulling it out carefully. Dispose after use.

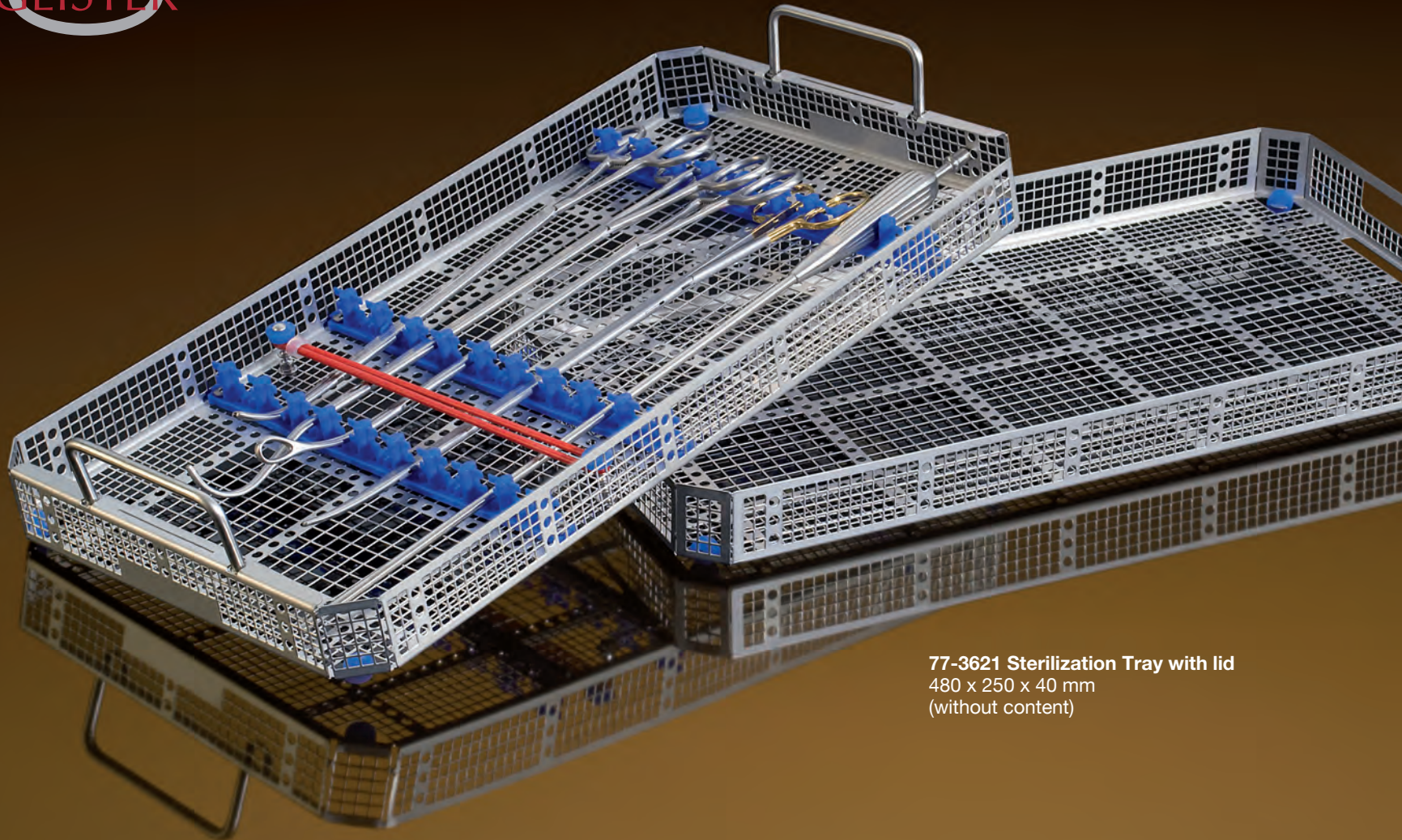

77-3621 Sterilization Tray with lid
480 x 250 x 40 mm
(without content)

Suggested Instrument Kits

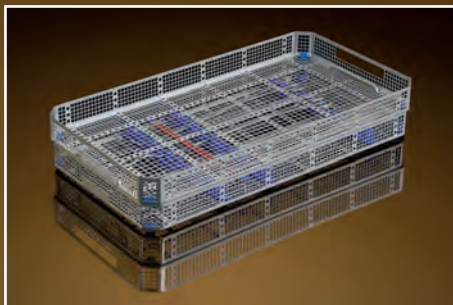
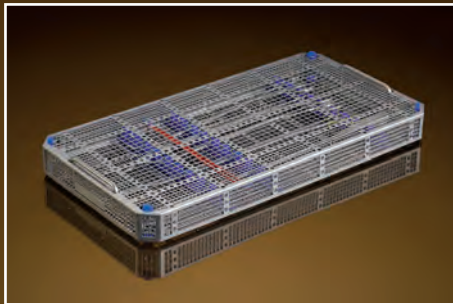
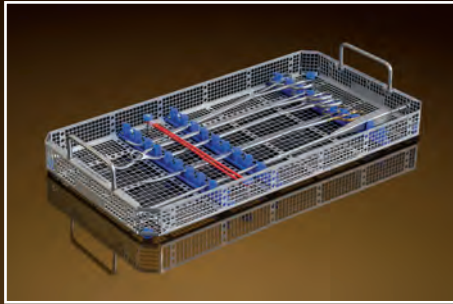
**01-1374 VATS/ThoraGate™ Kit large**

34-7301	1x	Transthoracic Aortic Clamp, 36 cm, 100 mm, curved
34-7302	1x	Transthoracic Aortic Clamp, 32 cm, 50 mm, curved
34-7303	1x	Transthoracic Aortic Clamp, 34 cm, 75 mm, curved
34-7325	1x	ThoraGate™ Allis Forceps, 34 cm, curved, with ratchet
34-7313	1x	ThoraGate™ DeBakey Cooley Forceps 35 cm, right angled jaws
34-7317	1x	ThoraGate™ Harken #1 Lung Clamp 35 cm, without ratchet
34-7318	1x	ThoraGate™ Harken #2 Lung Clamp 35 cm, without ratchet
34-7330	1x	ThoraGate™ Foerster Lung Grasper 33,5 cm, curved, with ratchet
34-7328	1x	ThoraGate™ Foerster Lung Grasper 33,5 cm, slim, curved, with ratchet
34-7335	1x	ThoraGate™ Duval Lung Grasper 33,5 cm, curved, 15 mm, with ratchet
34-7334	1x	ThoraGate™ Duval Lung Grasper 33,5 cm, curved, 25 mm, with ratchet
34-7323	1x	ThoraGate™ TC Metzenbaum Scissors 36 cm, slightly curved
34-7352	1x	ThoraGate™ TC Needle Holder 33,5 cm, curved, with ratchet
34-7380	1x	ThoraGate™ Yankauer Suction Tube 46 cm, Ø 5 mm, straight
34-7381	1x	ThoraGate™ Yankauer Suction Tube 46 cm, Ø 5 mm, with finger hole, straight
77-3621	2x	ValveGate™PRO Special Tray DIN, 480x250x40 mm, with lid
29-1399	1x	ValveGate™ Soft Tissue Protector, single use, pack of 2, regular size
29-1399S	1x	ValveGate™ Soft Tissue Protector, single use, pack of 2, small size

01-1373 VATS/ThoraGate™ Kit small

34-7301	1x	Transthoracic Aortic Clamp, 36 cm, 100 mm, curved
34-7330	1x	ThoraGate™ Foerster Lung Grasper 33,5 cm, curved, with ratchet
34-7328	1x	ThoraGate™ Foerster Lung Grasper 33,5 cm, slim, curved, with ratchet
34-7336	1x	ThoraGate™ Atraumatic Duval Lung Grasper, 32,5 cm, curved, with ratchet
34-7323	1x	ThoraGate™ TC Metzenbaum Scissors 36 cm, slightly curved
34-7352	1x	ThoraGate™ TC Needle Holder 33,5 cm, curved, with ratchet
34-7380	1x	ThoraGate™ Yankauer Suction Tube 46 cm, Ø 5 mm, straight
77-3621	1x	ValveGate™PRO Special Tray DIN, 480x250x40 mm, with lid
29-1399	1x	ValveGate™ Soft Tissue Protector, single use, pack of 2, regular size
29-1399S	1x	ValveGate™ Soft Tissue Protector, single use, pack of 2, small size



GEISTER Medizintechnik GmbH

Föhrenstrasse 2 | D-78532 Tuttlingen | Germany

☎ +49 7461 / 966240 | 📠 +49 7461 / 9662422

www.geister.com | info@geister.com